

Curva Vertical Externa 90°

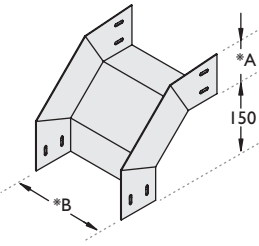

Referência S 7.007

*A=Altura *B=Base

Curva Vertical Interna 90°

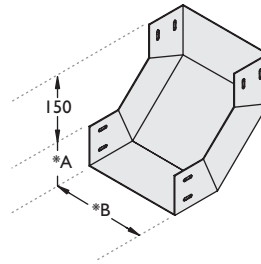

Referência S 7.008

Junção à Direita 45°

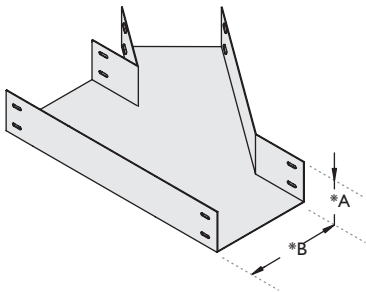

Referência S 7.009

Junção à Esquerda 45°

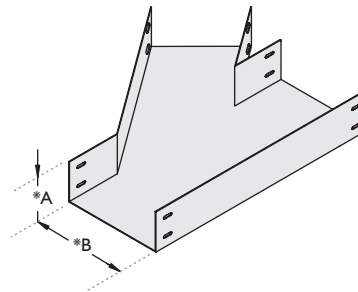

Referência S 7.010

Cruzeta 90°

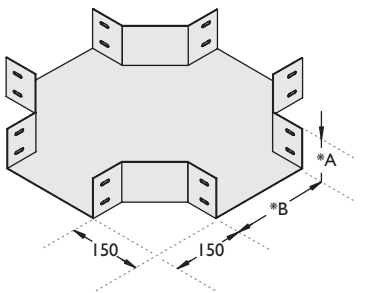

Referência S 7.011

Cruzeta Reta 90°

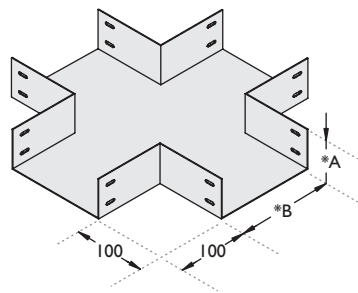

Referência S 7.012

“T” Vertical Subida

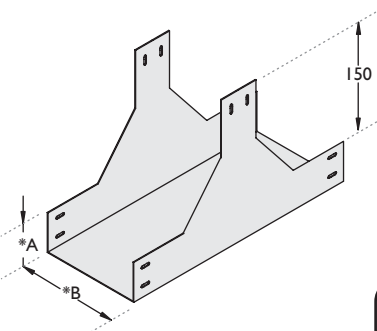

Referência S 7.013

“T” Vertical Descida

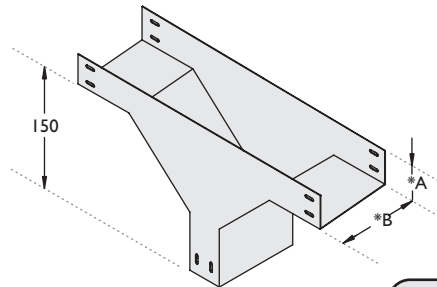

Referência S 7.014